

目 录

一、运输作业组织与管理模块..... 2

二、仓储与配送作业组织与管理模块..... 34

三、国际物流作业组织与管理模块..... 150

四、 快递物流作业组织与管理模块.....	213
-----------------------	-----

湖南商务职业技术学院物流管理专业学生技能考核题库

一、运输作业组织与管理模块

○

○

○

--	--	--

○

○

--	--	--	--	--

() 任务描述

- :
-
-



<input type="checkbox"/> <input type="checkbox"/>				<input type="checkbox"/> <input type="checkbox"/>				
<input type="checkbox"/> <input type="checkbox"/>								
						<input type="checkbox"/> <input type="checkbox"/> <input type="checkbox"/> <input type="checkbox"/>		



() 任务描述:

-
-
-



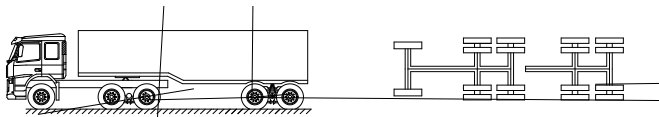
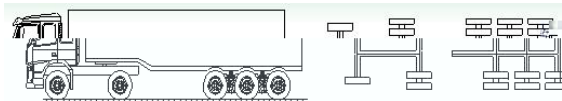

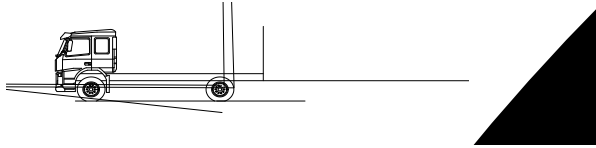
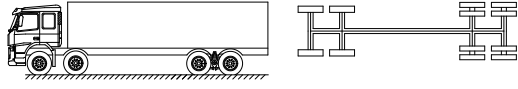
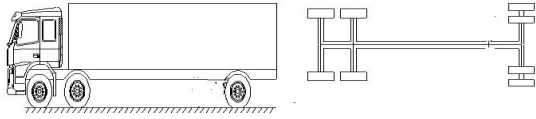

() 任务描述:



○

○

○

○

○

() 任务描述



D

<input type="checkbox"/> <input type="checkbox"/>			<input type="checkbox"/> <input type="checkbox"/>						
<input type="checkbox"/> <input type="checkbox"/>									
						<input type="checkbox"/> <input type="checkbox"/> <input type="checkbox"/> <input type="checkbox"/>			



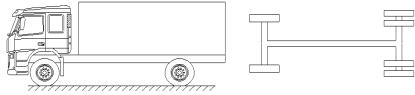
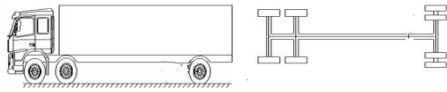
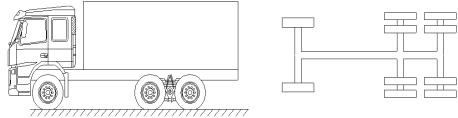

2

3

4

() 任务描述



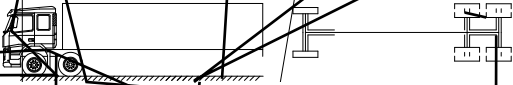
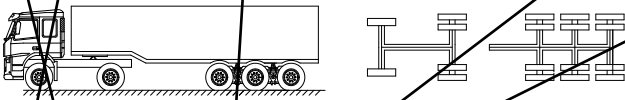
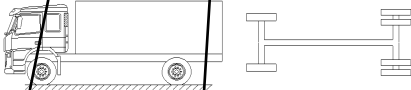



() 任务描述

-
-
-
-
-

() 任务描述

()

()

)	()		

()

()

()

()

()

○

()			

Sailing Schedule from : Shenzhen,Shenzhen,Guangdong,China

To : Los Angeles,Los Angeles,CA,United States

Origin City : Shenzhen,Shenzhen,Guangdong,China

Destination City : Los Angeles,Los Angeles,CA,United States

CY/DOOR

CY/DOOR

序列号	航线	船名	航次	截关时间	装货港	预计离港时间	实际离港时间	卸货港
1	YPSW	YM UNISON	59E	2016-04-22 17:00	Yantian	2016-04-25		Los Angeles
2	SEA	NORTHERN JAVELIN	002E	2016-04-23 12:00	Yantian	2016-04-27		Long Beach
3	AAS2	CMA CGM LIBRA	095TXE	2016-04-25 16:00	Yantian	2016-04-28		Long Beach
4	YPSW	YM UBIQUITY	22E	2016-04-29 17:00	Yantian	2016-05-02		Los Angeles
5	SEA	C SCL PUSAN	117E	2016-04-30 12:00	Yantian	2016-05-04		Long Beach
6	AAS2	CMA CGM COLUMBA	097TXE	2016-05-02 16:00	Yantian	2016-05-05		Long Beach
7	SEA	COSCO NINGBO	069W	2016-05-06 11:00	Yantian	2016-05-08		Long Beach
8	YPSW	YM JIREBY	50E	2016-05-06 17:00	Yantian	2016-05-09		Los Angeles
9	SEA	COSCO EXCELLENCE	027E	2016-05-07 12:00	Yantian	2016-05-11		Long Beach
10	AAS2	CMA CGM CENTAURUS	099TXE	2016-05-09 16:00	Yantian	2016-05-12		Long Beach
11	YPSW	YM MASCULINITY	32E	2016-05-13 17:00	Yantian	2016-05-16		Los Angeles



干货箱



	箱体内部尺寸			箱体内容积及载重量		箱门开度尺寸	
	L	W	H	Cu	P	W	H
20'	5898	2352	2393	33.2	21740/28230#	2340	2280
40'	12032	2352	2393	67.7	26630	2340	2280
HC	12032	2352	2698	76.3	26520	2340	2585

冷藏箱



	箱体内部尺寸			箱体内容积及载重量	
	L	W	H	Cu	P
20'	5444	2284	2267	28.5	21135/27160#
40'	11583	2284	2250	58.7	26580
HC	11583	2284	2556	67.9	26380

开顶箱



	箱体内部尺寸			箱体内容积及载重量	
	L	W	P	Cu	P
20'	5900	2330	2337	32.6	21740
40'	12025	2330	2337	65.8	26410

○

○

() 实施条件

() 考核时量

() 评分细则

1

() 任务描述



		<input type="checkbox"/>	<input type="checkbox"/>	<input type="checkbox"/>	<input type="checkbox"/>

<input type="checkbox"/>		<input type="checkbox"/>			
<input type="checkbox"/>		<input type="checkbox"/>			



() 实施条件

() 考核时量

() 评分细则

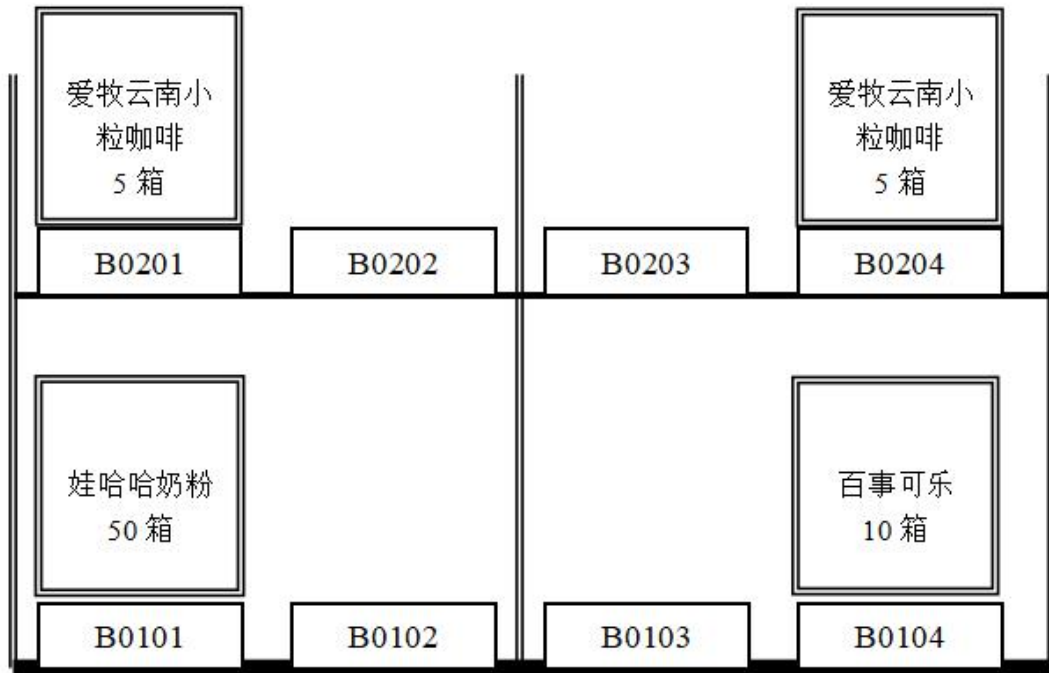

产品运输单

-
-
-
-
-
-
-
-

80				

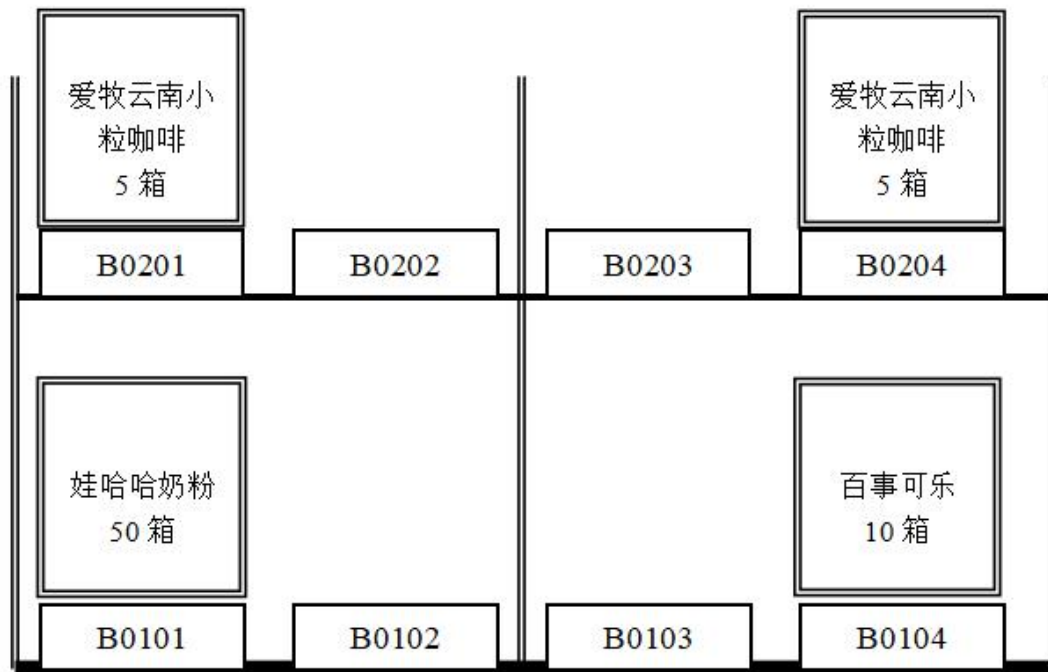
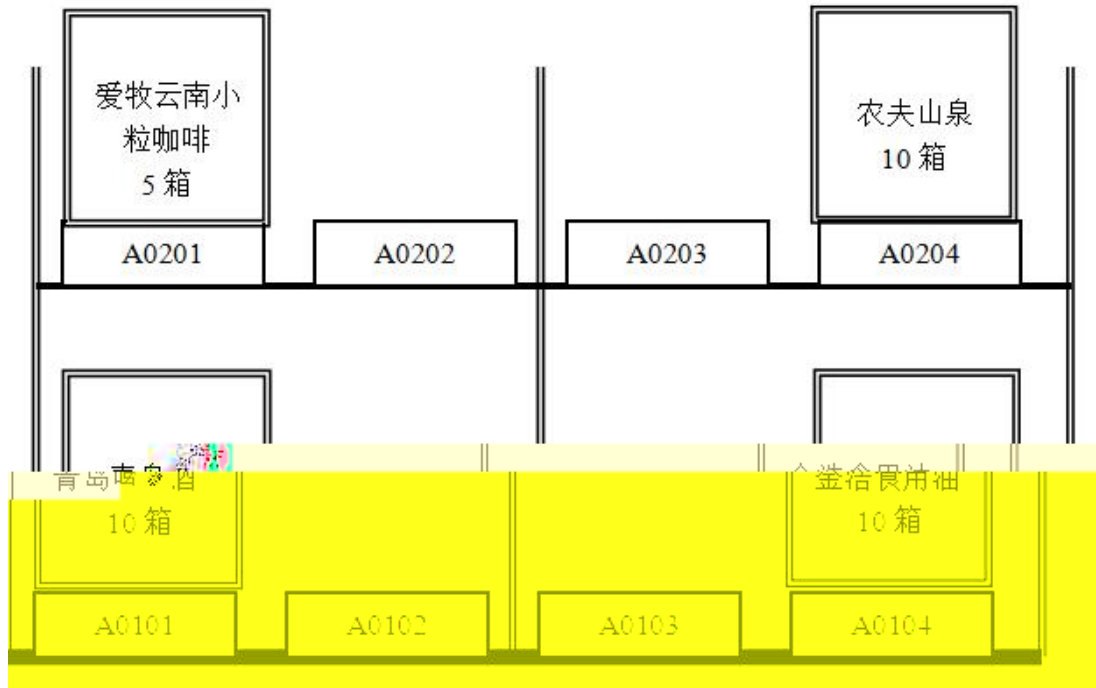

产品运输单

-
-
-
-
-
-
-
-

		Date		Page	
No.	Description	Particulars	Debit	Credit	Balance
		Total			

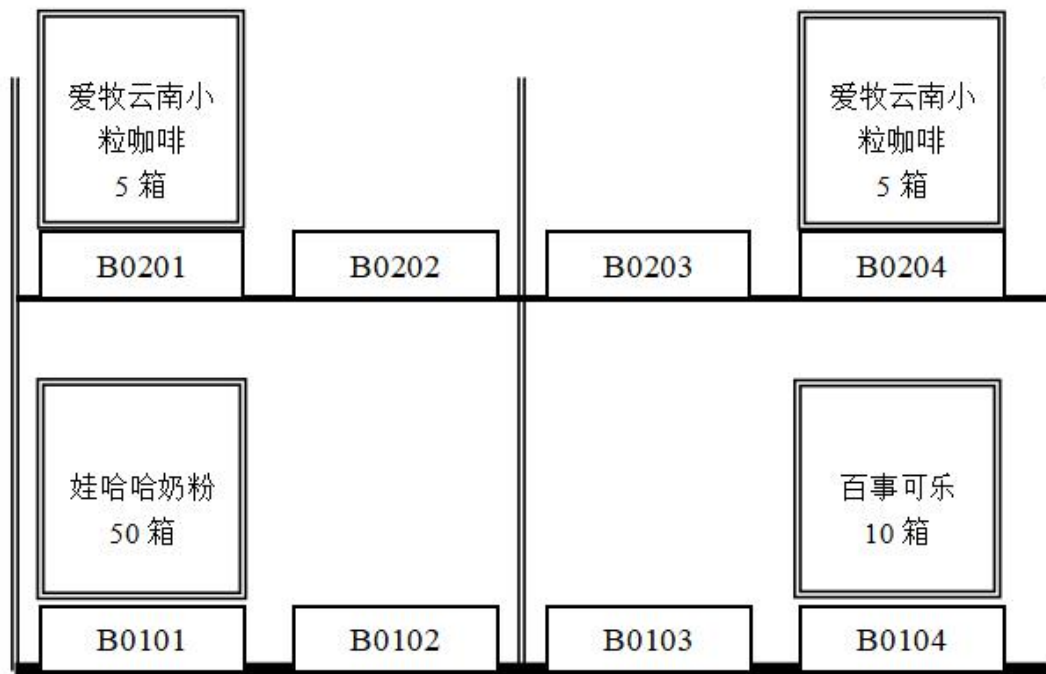
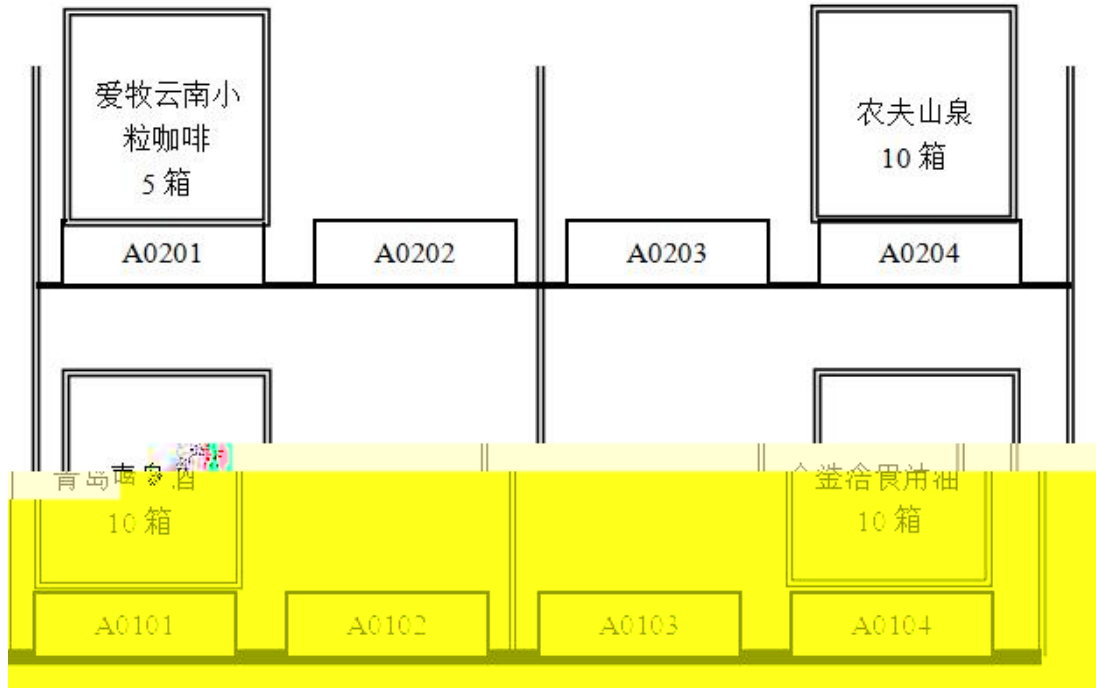



产品运输单

-
-
-
-
-
-
-
-

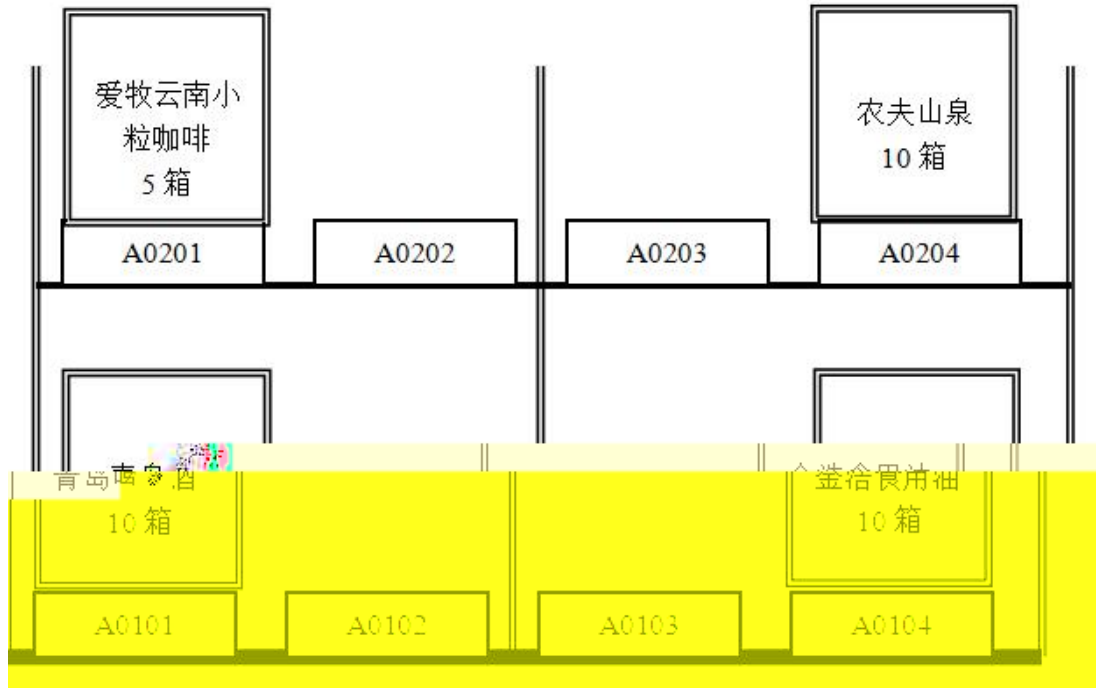

产品运输单

-
-
-
-
-
-
-
-

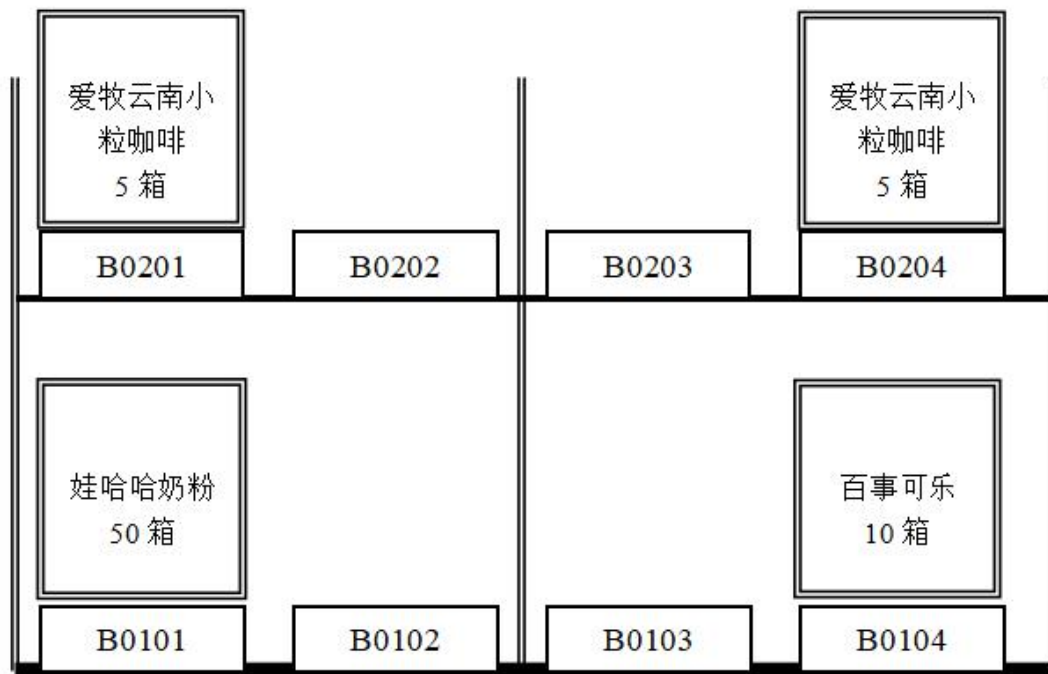

产品运输单

○

○

○

○

○

X, 'i

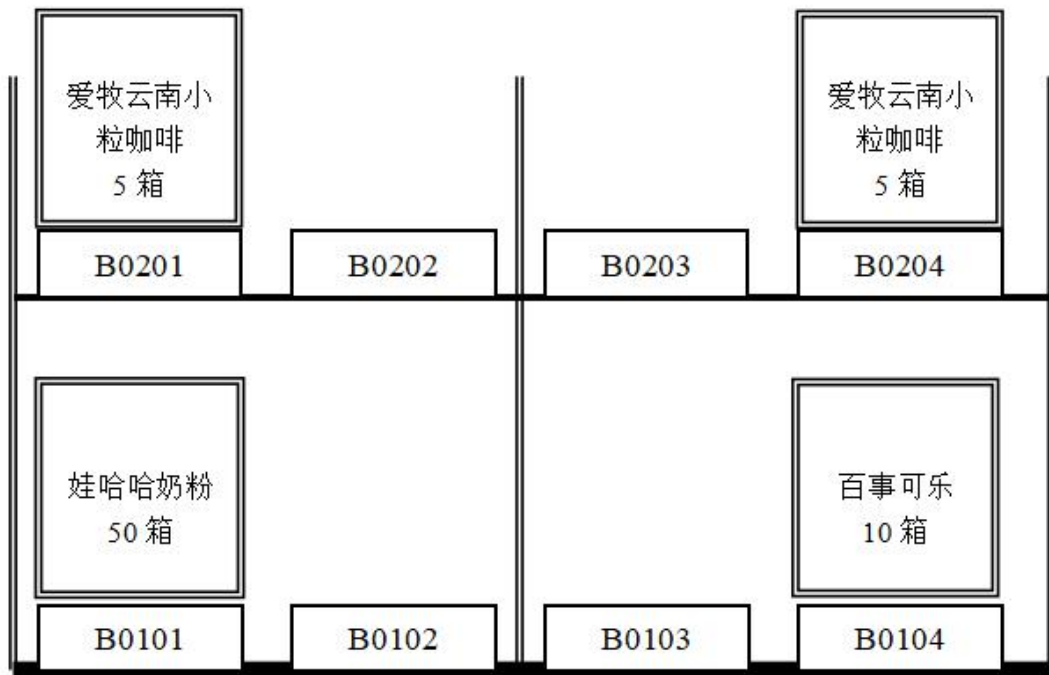
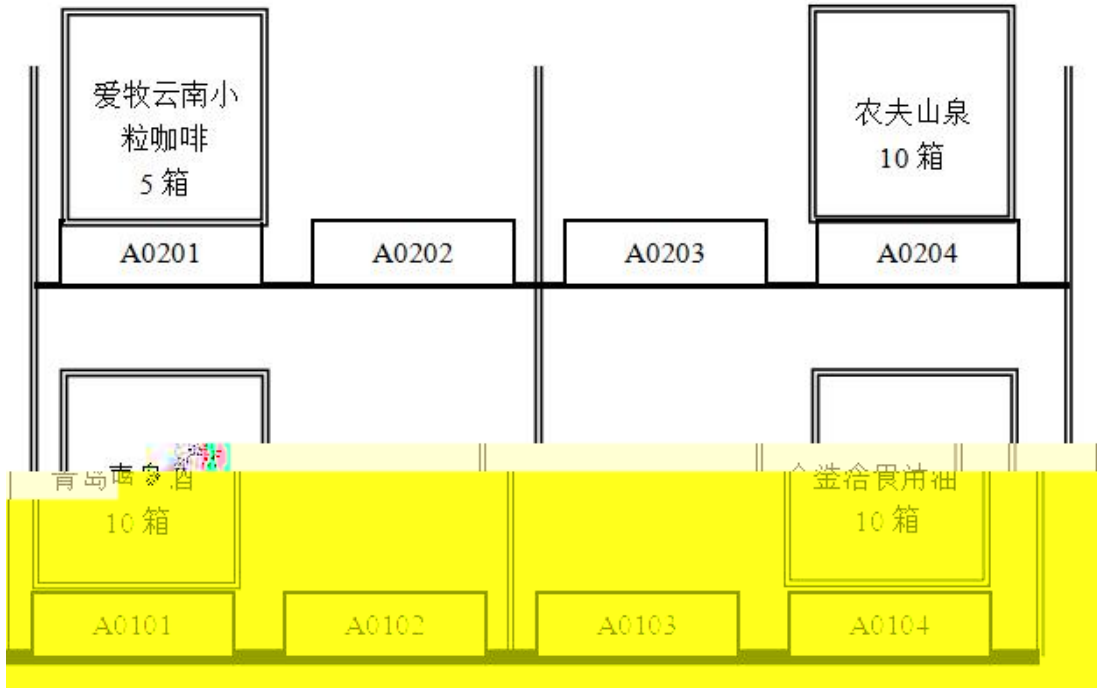

产品运输单

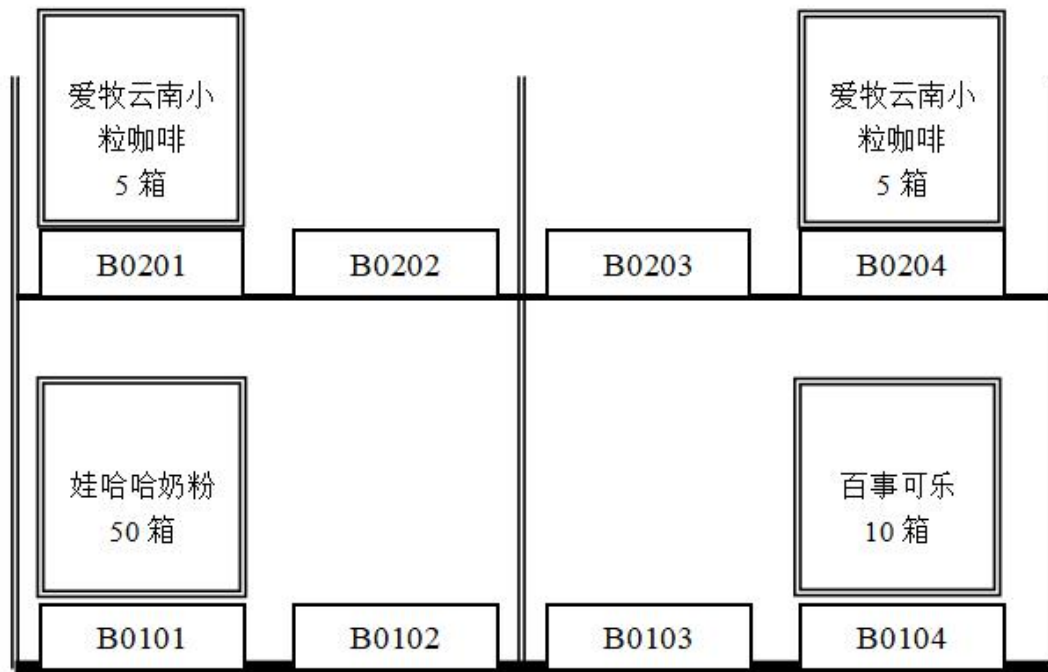
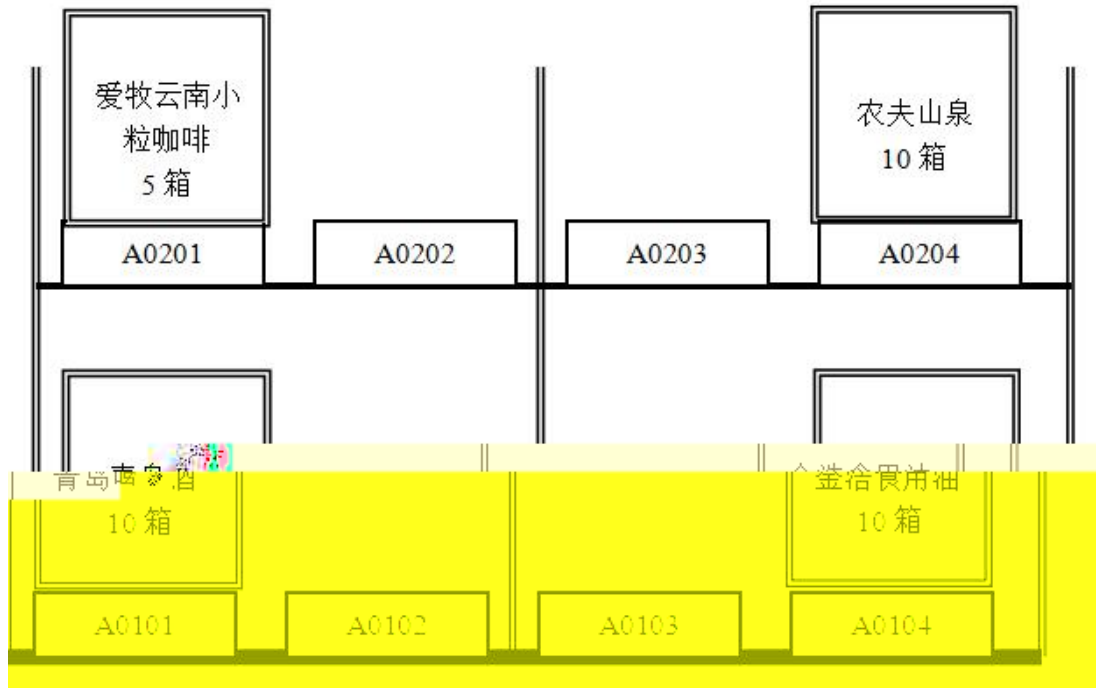

产品运输单

-
-
-
-
-
-
-
-
-

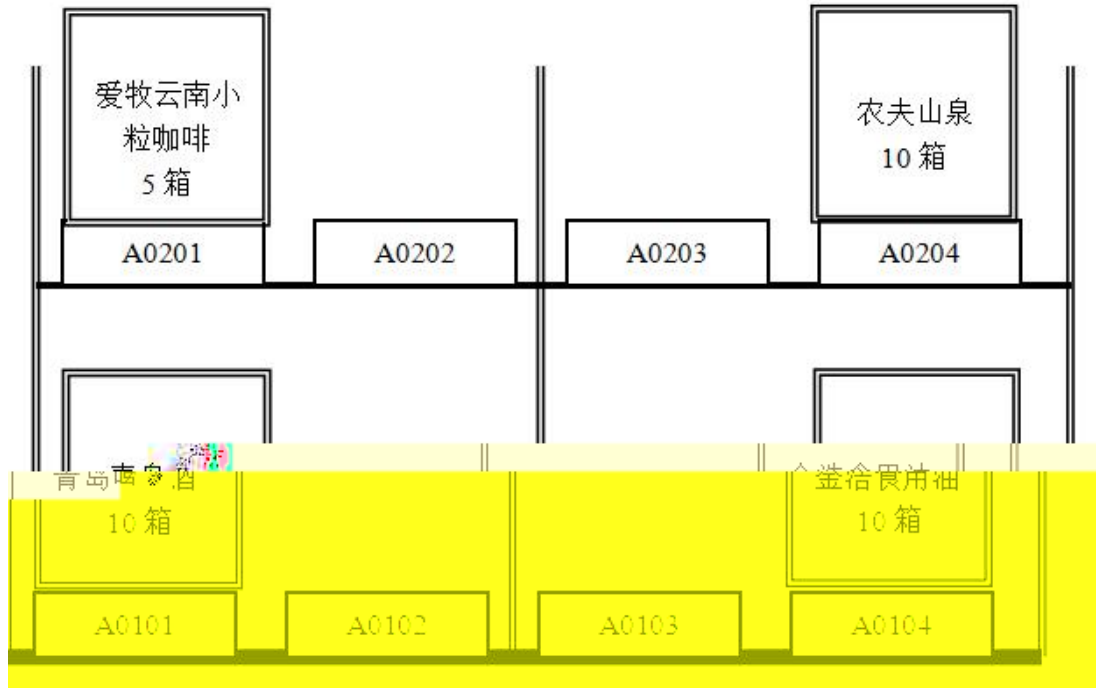

产品运输单

-
-
-
-
-
-
-
-
-

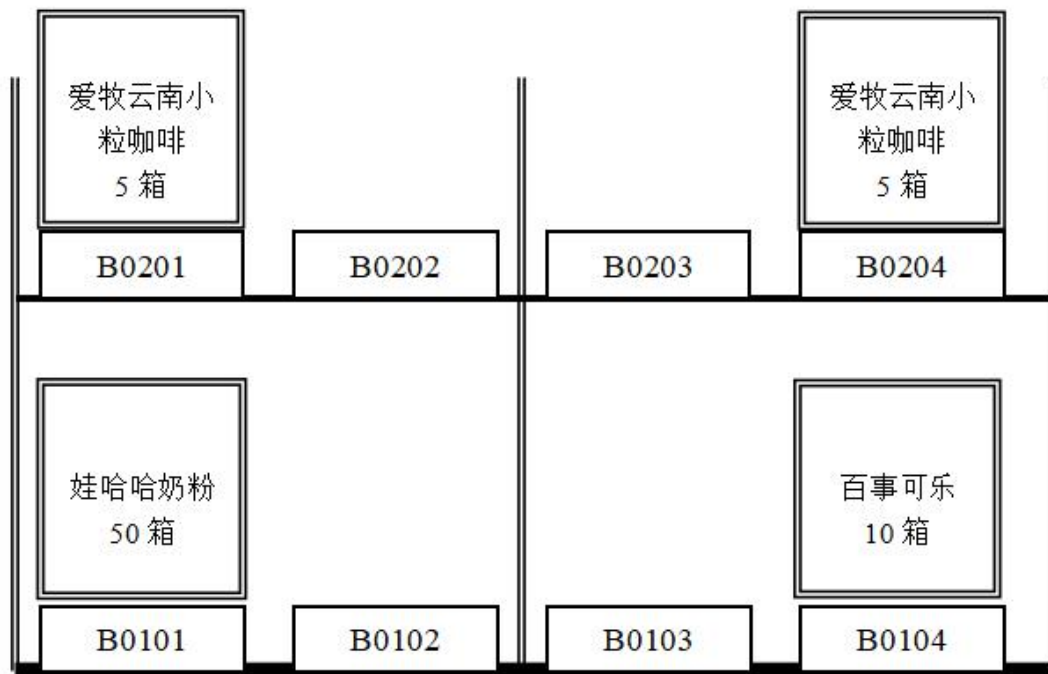

产品运输单

-
-
-
-
-
-
-
-
-

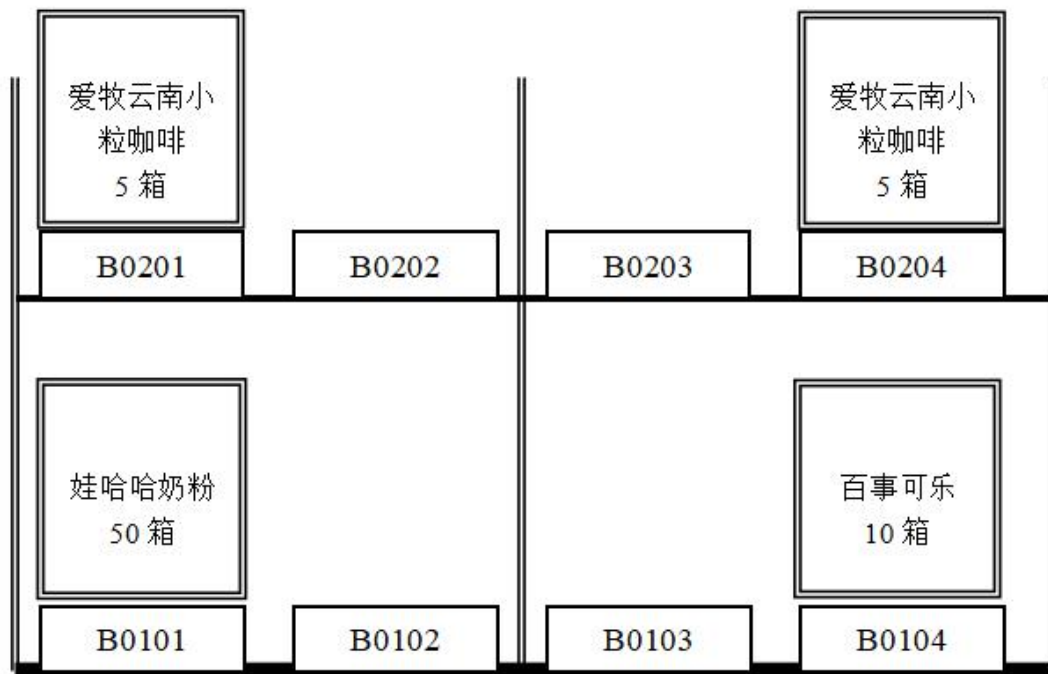
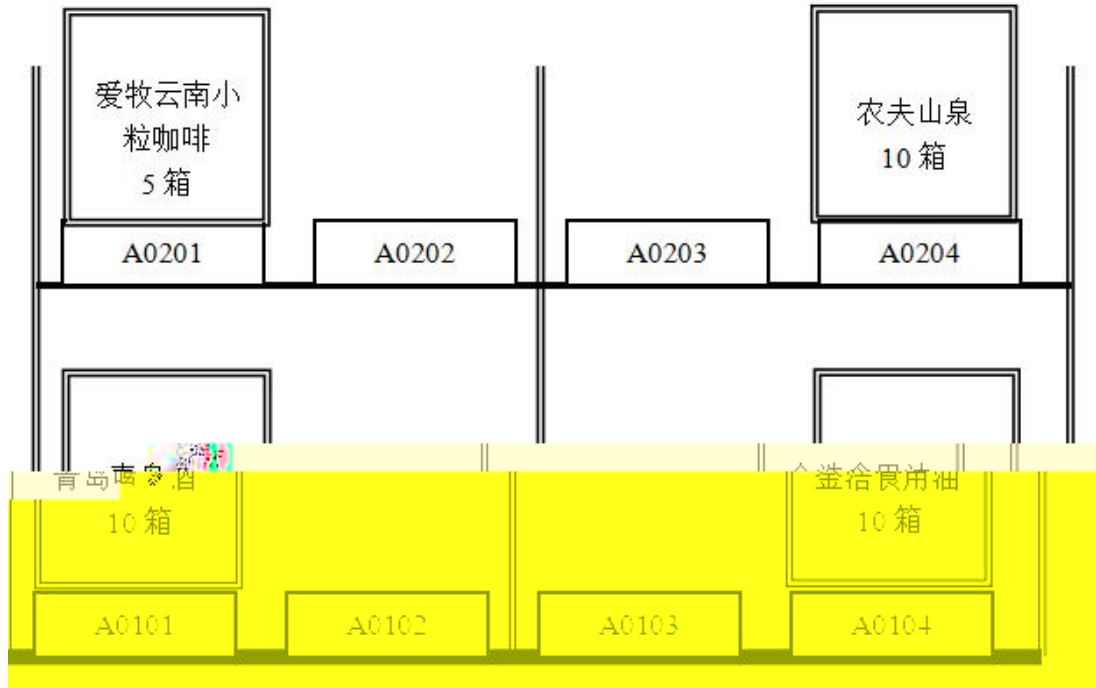

产品运输单

-
-
-
-
-
-
-
-

○

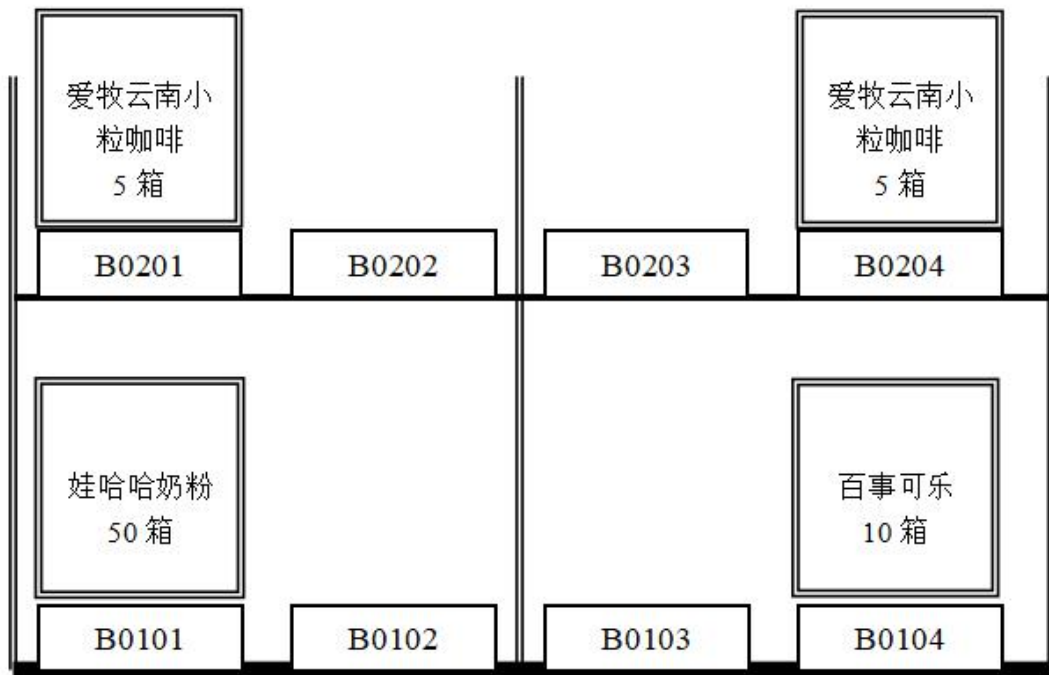
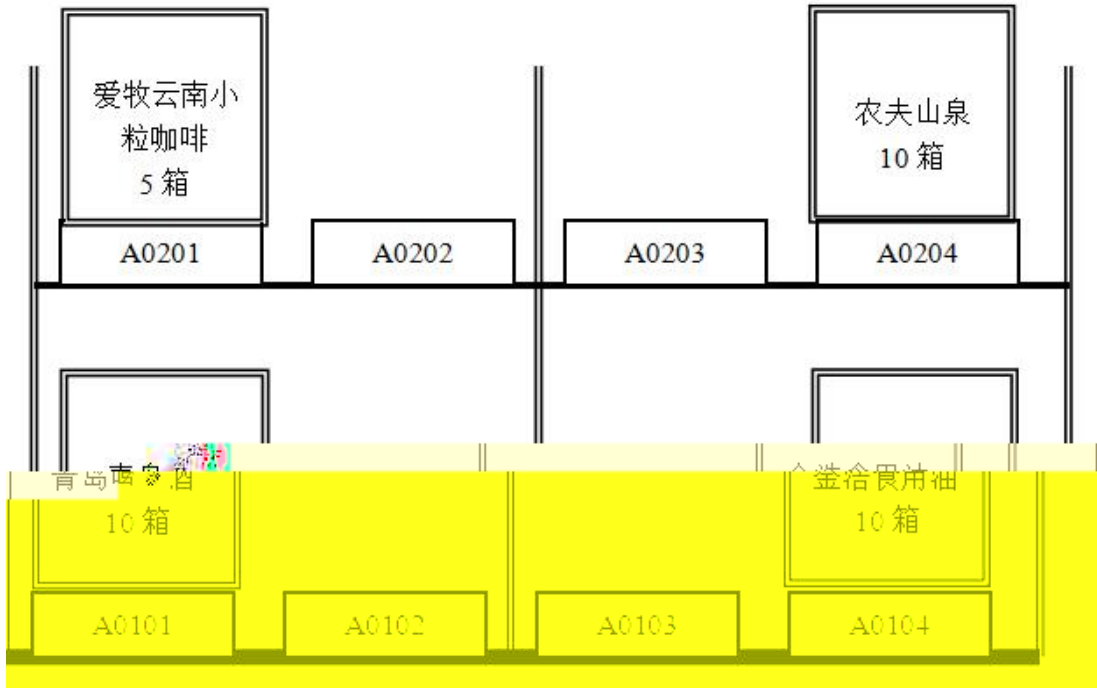



--	--	--	--	--	--

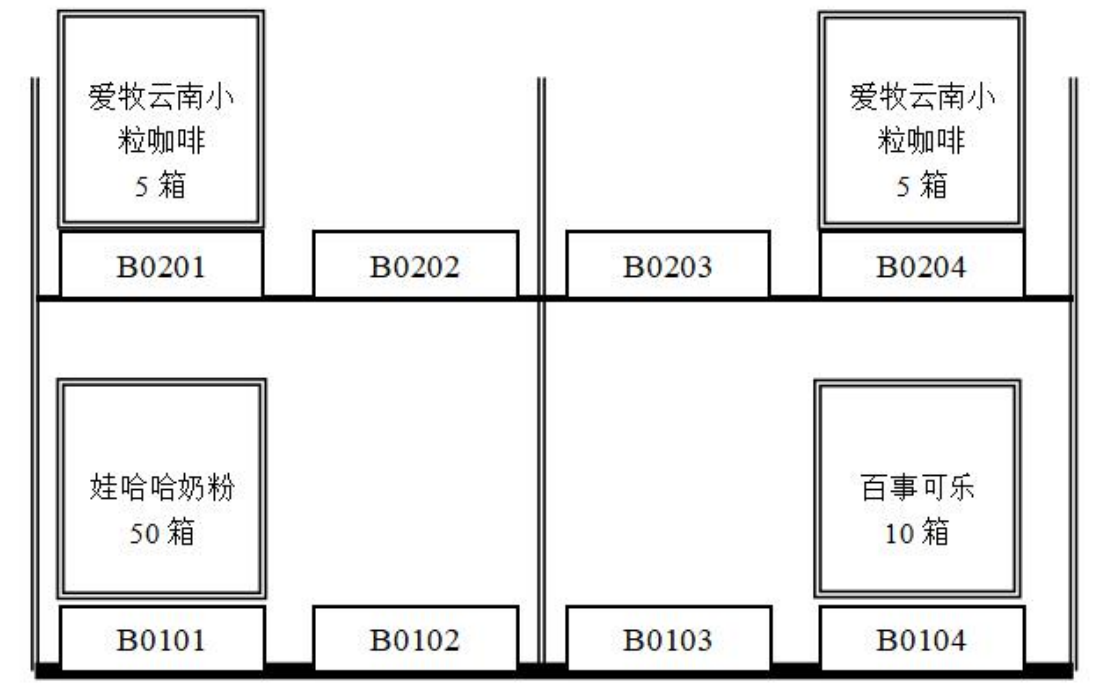

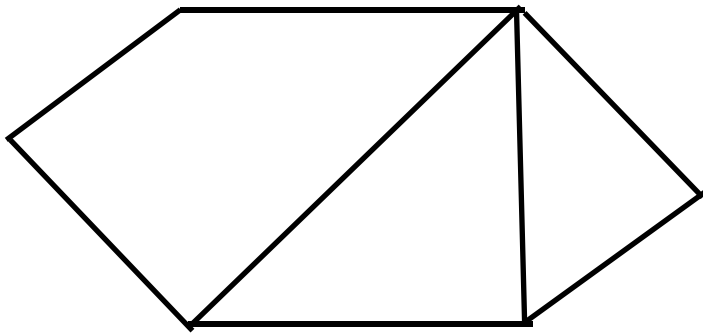

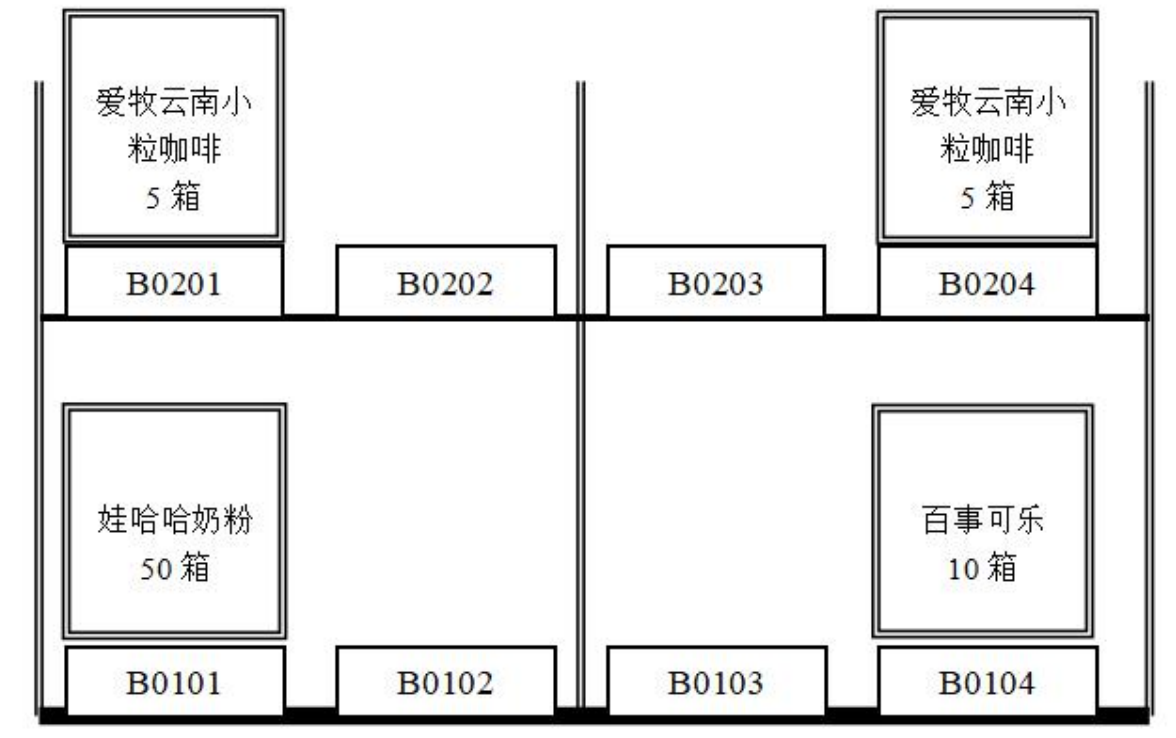
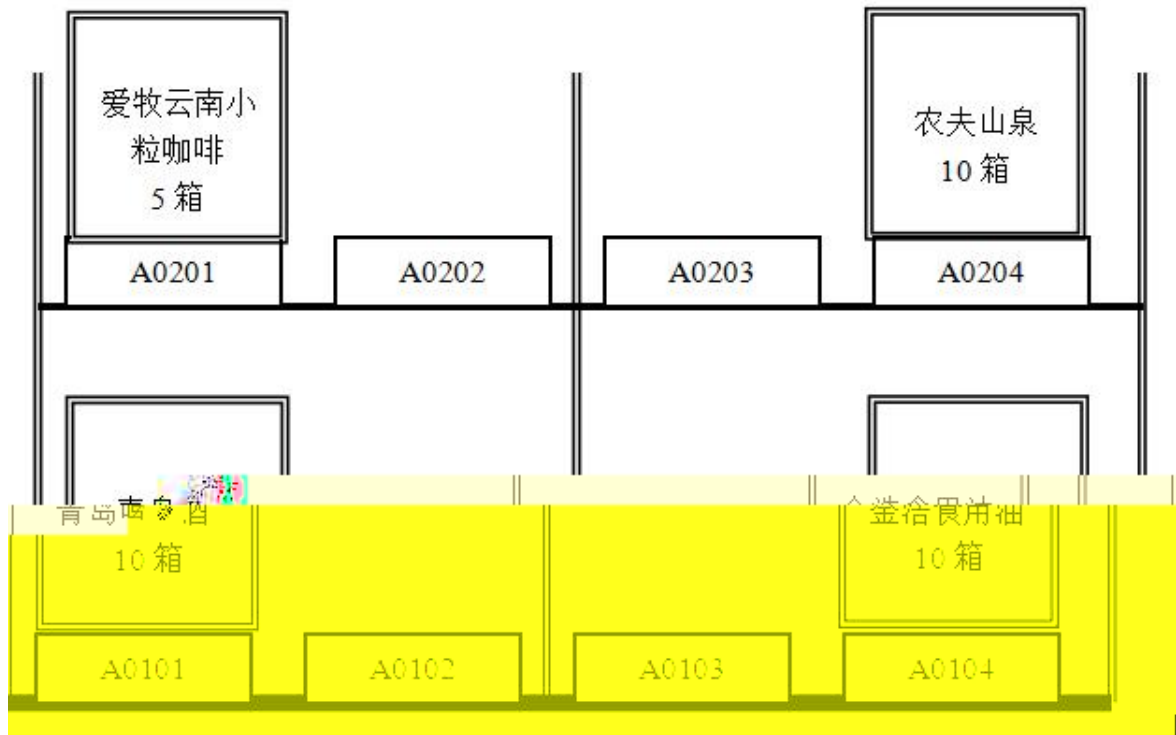

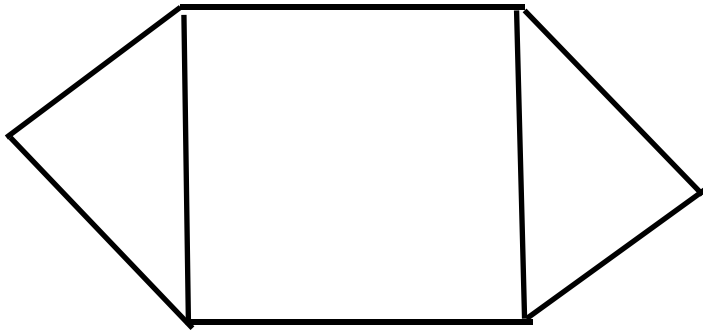

1

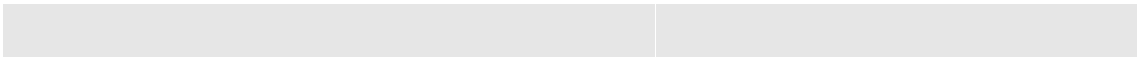

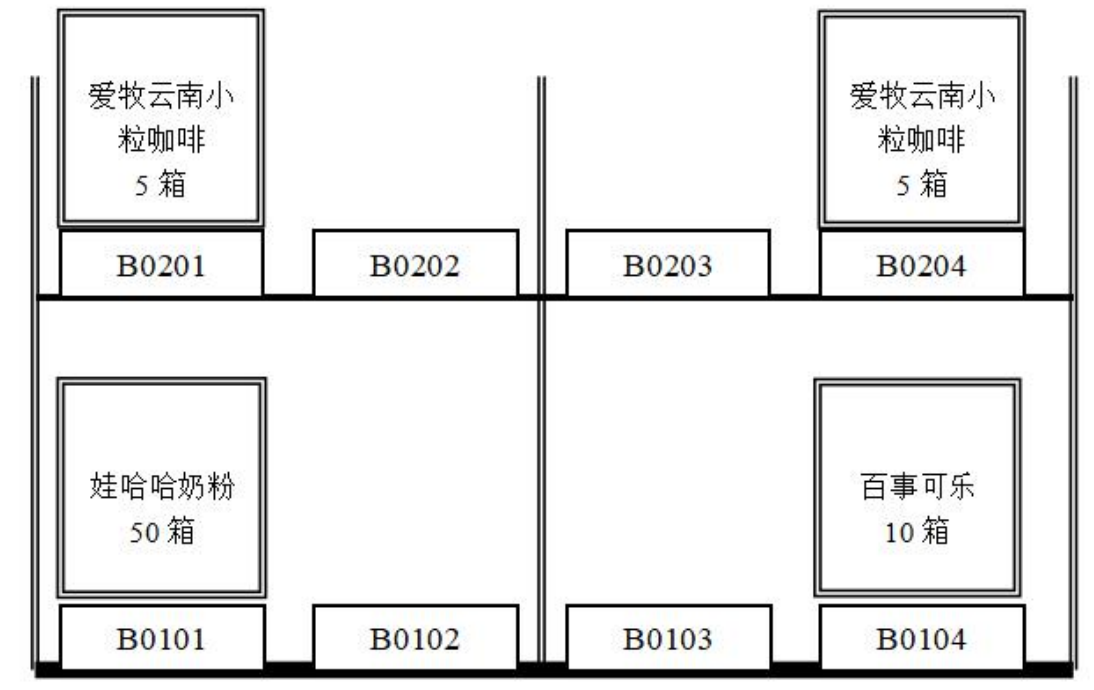
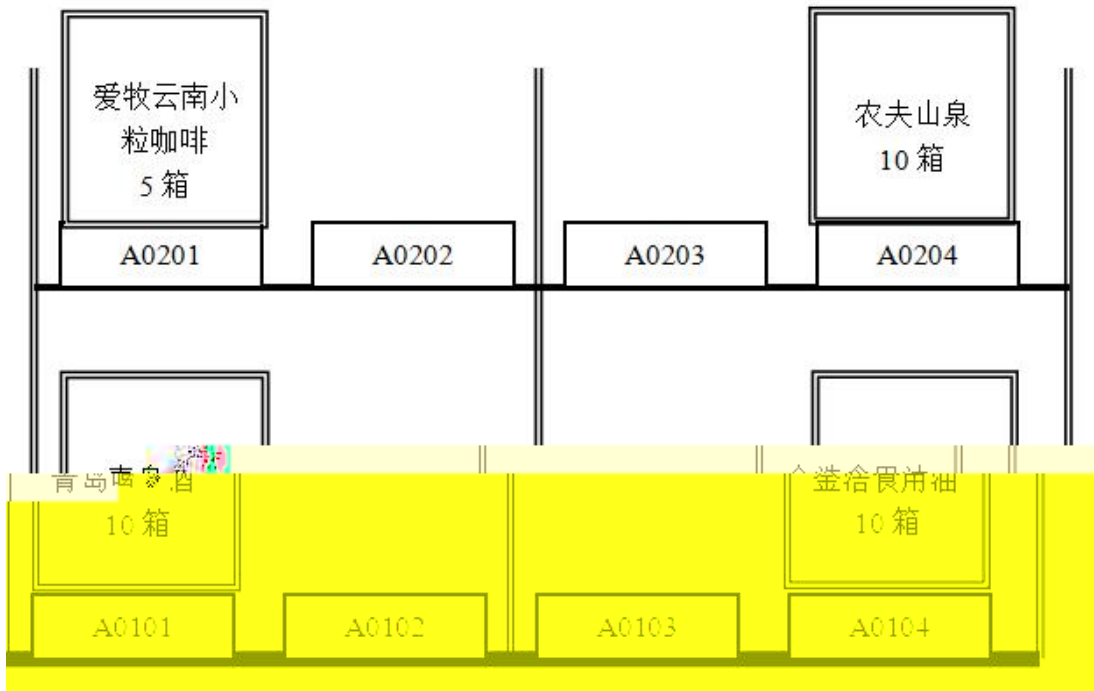

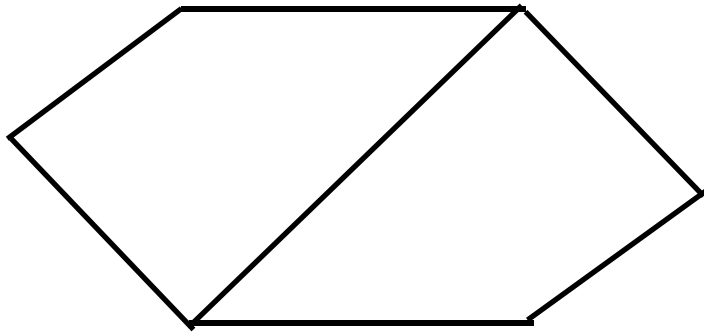

1

--	--	--	--	--	--

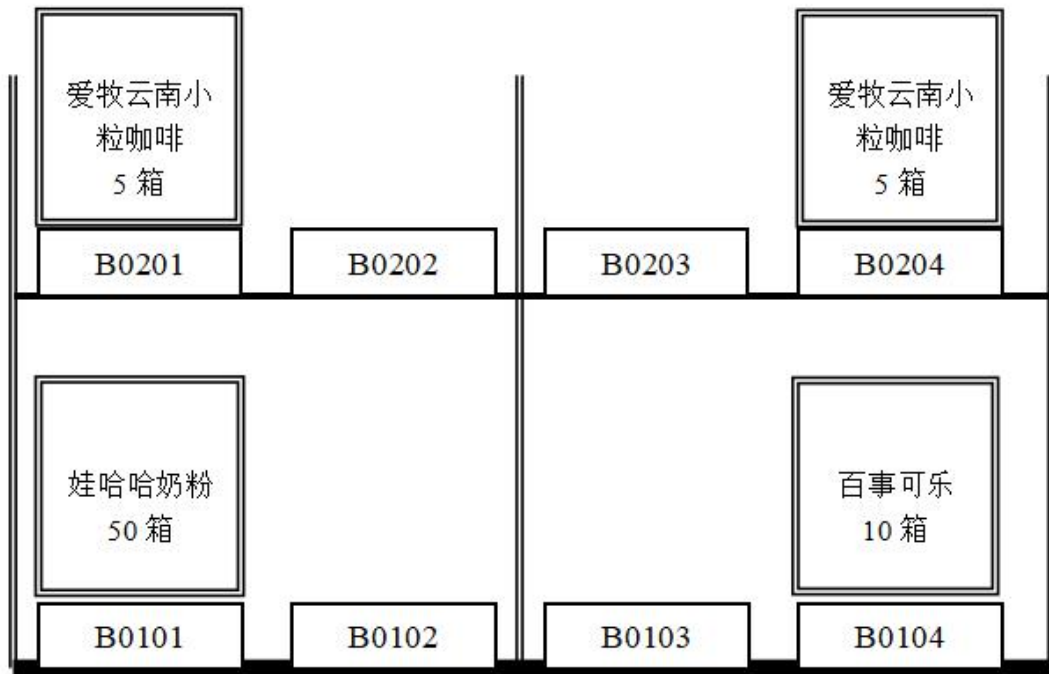

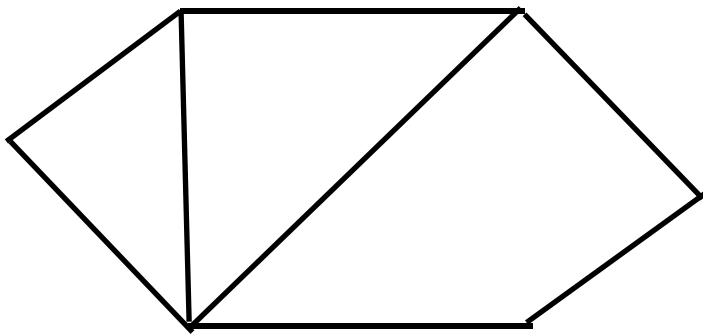

○

○

○

○

○

○

○

○

--	--

○

○

三、国际物流作业组织与管理模块

○

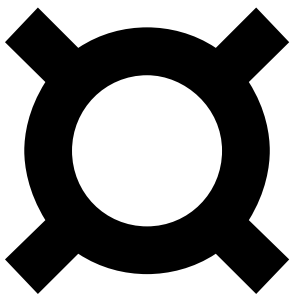

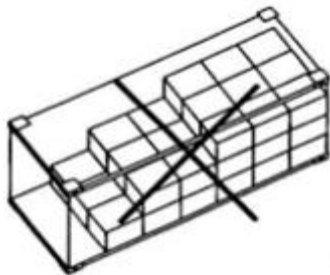
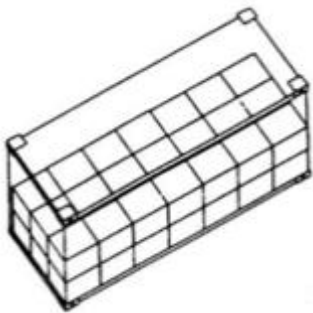

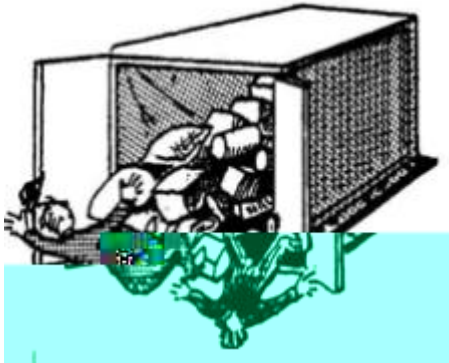
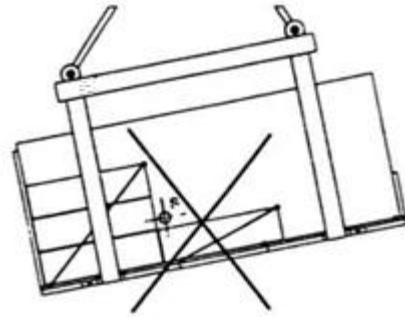

○

船公司	船名/航次	服务代码	航线	装船港/卸船港	启-达日期	天	挂港
Carrier	Voyage	Service	Lane	Load/Unload Port	ETD-ETA	Day	Port
MSC 地中海航运	MASTER 21702T		中国-香港台	HONG KONG 香港 HONGKONG 香港	02/25 (二)	10	港
NYK 日本邮船	ITALIAN EXPRESS 21024		中国-香港台	HONG KONG 香港 BANGKOK 曼谷	02/25 (二)	8	港
CMA-CGM 法国达飞	CMA CGM GENEO 21049E		中国-欧洲	XIAMEN 厦门 DUBAI 迪拜	02/25 (二)	30	港
ALDIA 阿力迪亚	AVINDIA PLATON 21024T		中国-日本	SHANGHAI 上海 YOKOHAMA 横滨	02/25 (二)	40	港
OOCL 东方海外	ORION KATHRYN 21024OE		中国-欧洲	HONG KONG 香港 MUMBAI 孟买	02/25 (二)	20	港
PSL 星洲船务	PSL PERMASAN VEN114		中国-日本 欧洲-澳洲	SHANGHAI 上海 MADRAS 马德拉斯	02/25 (二)	38	港
OOCL 东方海外	ORION KONG 21024OE	CHINA/INDIA AM/TH	中国-香港台	XINBEI 新比 HONG KONG 香港	02/25 (二)	10	港
ARMARIE 阿利埃里	HELEN P 21024		中国-欧洲	HONGKONG 香港 MONTEC	02/25 (二)	10	港
DEAM 德美船务	DEAM SAN NICOLA 21024E		中国-日本	SHANGHAI 上海 FUKUOKA 福冈	02/25 (二)	40	港
OOCL 东方海外	ORION EXPRESS 21024OE	Faridat Atc Am/Th/PAO	中国-日本	SHANGHAI 上海 HONGKONG 香港	02/25 (二)	40	港

○
○

BEIJING	CN		BJ\$
Y. RENMINBI	CNY		KGS
		100	10000
		200	20000
		300	30000
		400	40000
		500	50000

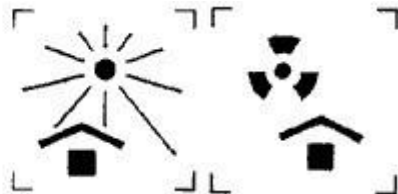
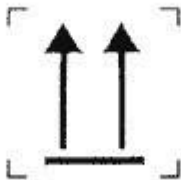
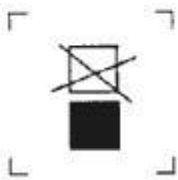

○

○

○

集装箱设备交接单
EQUIPMENT INTERCHANGE RECEIPT

OUT 出场

No.

用箱人/运箱人(CNTR. USER/HAULIER)			提箱地点(PLACE OF DELIVERY)		
发往地点(DELIVERED TO)			返回/收箱地点(PLACE OF RETURN)		
船名/航次(VESSEL/VOYAGE No.)	集装箱号(CNTR. No.)	尺寸/类型(SIZE/TYPE)	营运人(CNTR. OPTR)		
提单号(B/L No.)	危险品类别(IMCO CLASS)	箱封号(SEAL No.)	免费期限(FREE TIME PERIOD)	运载工具牌号(TRUCK WAGON BARGE No.)	
货重(CARGO W.)	出场目的/状态(PPS OF GATE-OUT/STATUS)		进场目的/状态(PPS OF GATE-IN/STATUS)		出场日期(TIME-OUT) 月 日 时
出场检查记录(INSPECTION AT THE TIME OF INTERCHANGE)					
普通集装箱(GP. CNTR.)		冷藏集装箱(RP. CNTR.)		特种集装箱(SEL. CNTR.)	
<input type="checkbox"/> 正常(SOUND) <input type="checkbox"/> 异常(DEFFECTIVE)		<input type="checkbox"/> 正常(SOUND) 设定温度(SET) <input type="checkbox"/> 异常(DEFFECTIVE) 记录温度(RECORDED)		<input type="checkbox"/> 正常(SOUND) <input type="checkbox"/> 异常(DEFFECTIVE)	
发电机(GEN. SET)		<input type="checkbox"/> 正常(SOUND) <input type="checkbox"/> 异常(DEFFECTIVE)		<input type="checkbox"/> 正常(SOUND) <input type="checkbox"/> 异常(DEFFECTIVE)	
损坏记录及代号(DAMAGE CODE)					
<input type="checkbox"/> BR 破损 (BROKEN)		<input type="checkbox"/> D 凹痕 (DENT)		<input type="checkbox"/> M 丢失 (MISSING)	
<input type="checkbox"/> DR 污损 (DIRTY)		<input type="checkbox"/> DL 危标 (DGLABEL)			
左侧(LEFT SIDE)	右侧(RIGHT SIDE)	前端(FRONT)	内部(INSIDE)		
顶部(TOP)	底部(FLOOR BASE)	后端(REAR)	如有异状,请注明程度及尺寸(REMARK)		
除列明者外,集装箱设备交接时完好无损,箱封完整无误。 EQUIPMENT INTERCHANGED IN SOUND CONDITION AND SEAL INTACT UNLESS OTHERWISE STATED 码头/堆场值班员签署 (TERMINAL/DEPOT CLERK'S SIGNATURE) 用箱人/运箱人签署 (CONTAINER USER/HAULIER'S SIGNATURE)					
____日	____年____月____日	____年____月____日			

--	--	--	--	--	--

--	--	--

--	--	--	--	--	--

--	--	--	--	--	--

--	--	--	--	--	--	--	--

○



*6



#AIC 2024

○

--	--	--

--	--	--	--	--	--

○

○

○

○

四、 快递物流作业组织与管理模块

--	--	--	--	--	--

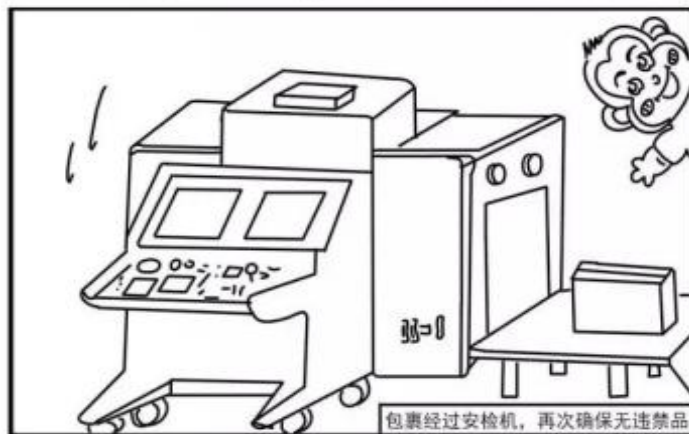
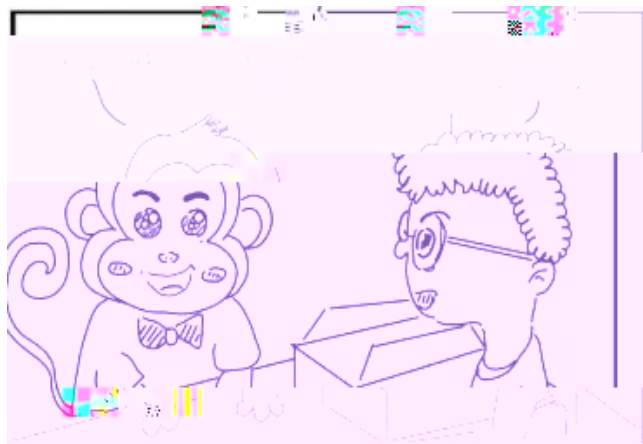

--	--	--	--	--	--

--	--	--	--	--	--

[想知道:中国成都理工大学校园快递具体在哪? 百度知道](#)

3个回答 - 提问时间: 2014年02月10日

最佳答案  均在银杏后面。宝盒、圆通、顺丰在电影院后面。中通、申通在图书馆下面。常用的是这几个。

zhidao.baidu.com/link?... 2014-02-15 - 百度快照 - 80%好评

--	--	--	--

--	--	--	--

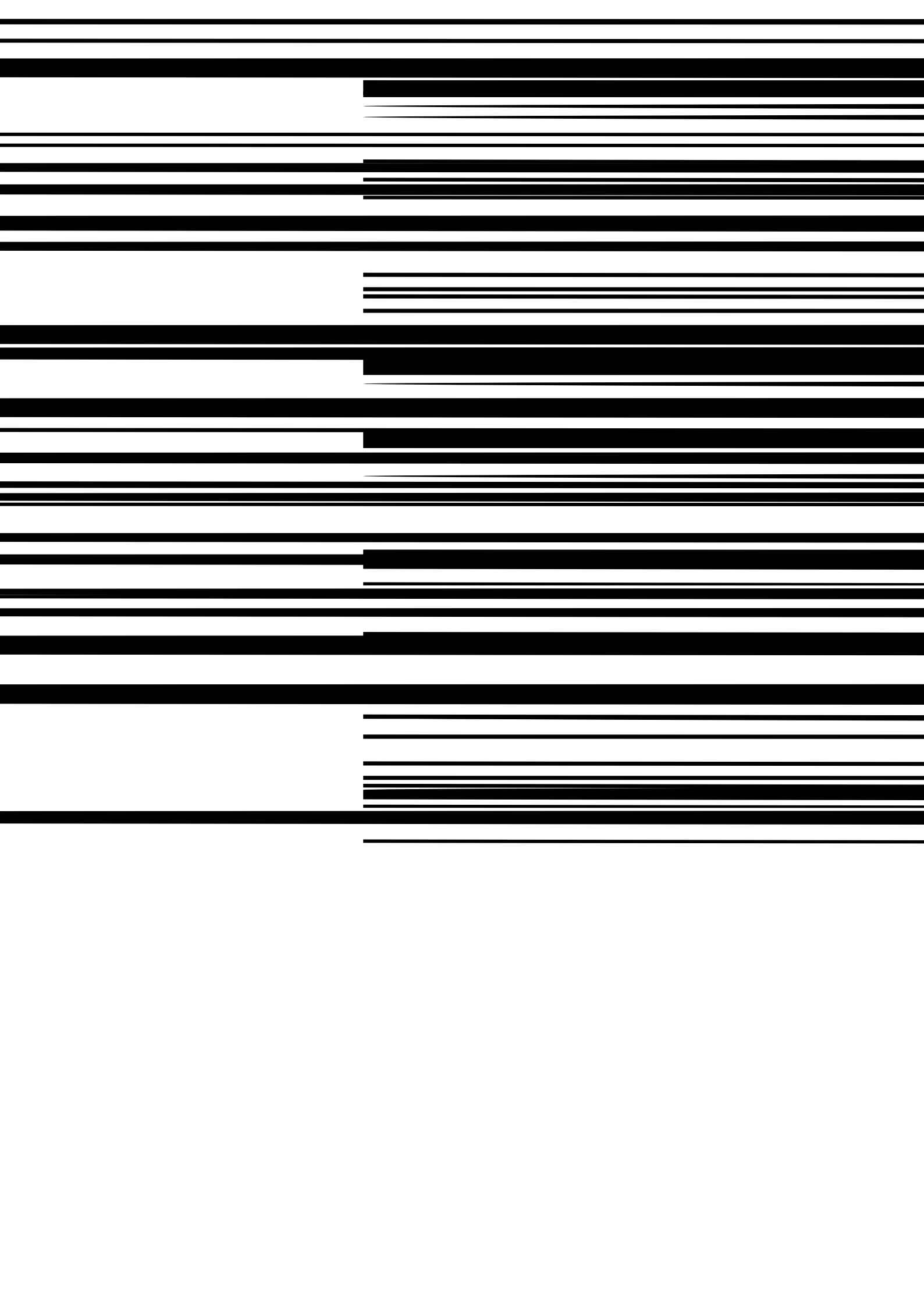

1

€6€NR

--

